

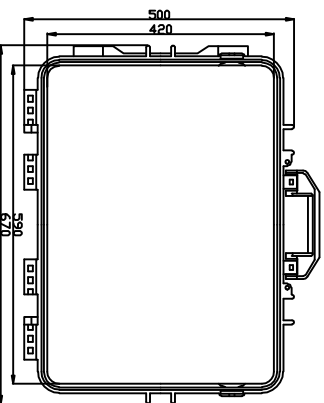

BASIC SIZE	0-3	>3-6	>6-10	>10-18	>18-30	>30-50	>50-80	>80-120	>120-180	>180-250
DIMS TOLERANCE	±0.14	±0.18	±0.22	±0.27	±0.33	±0.39	±0.46	±0.54	±0.63	±0.72

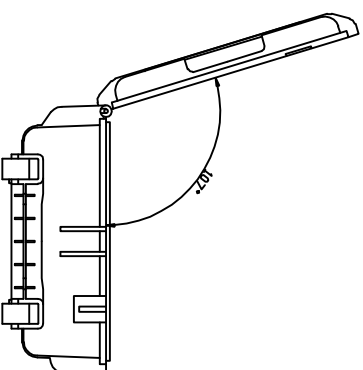
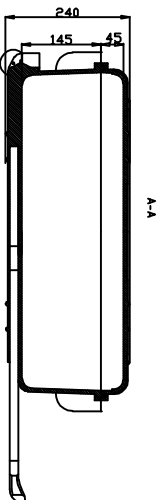
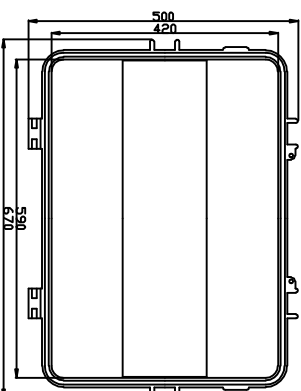
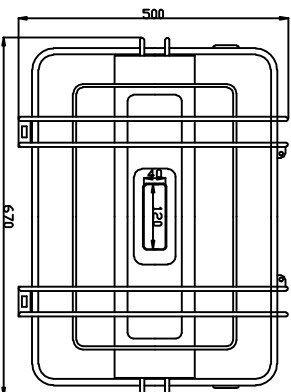
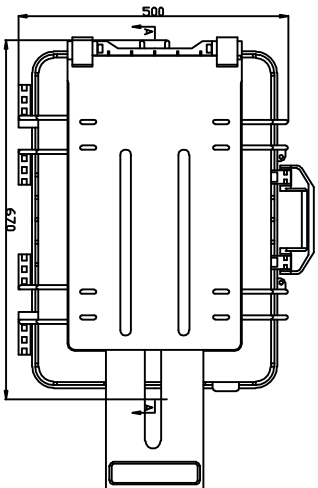

THE MACHINING TOLERANCES		NAME	DATE	 DRX EVEREST WWW.EVERESTCASE.COM
UNSPECIFIED TOLERANCES FOLLOW GB/1804-1992 IT13		DRAWN		
FDAM TOLERANCES		ENG APPR		TITLE
THE ANGLE TOLERANCES		QTY	1	MATERIAL
FIRST ANGLE PROJECTION		SCALE	1:1	UNIT
		SCALE	1:1	mm
		DD NOT SCALE DRAWING		/PART NO
				EPC020
				SHEET 1 OF 1
				EVEREST CASE
				ABS