

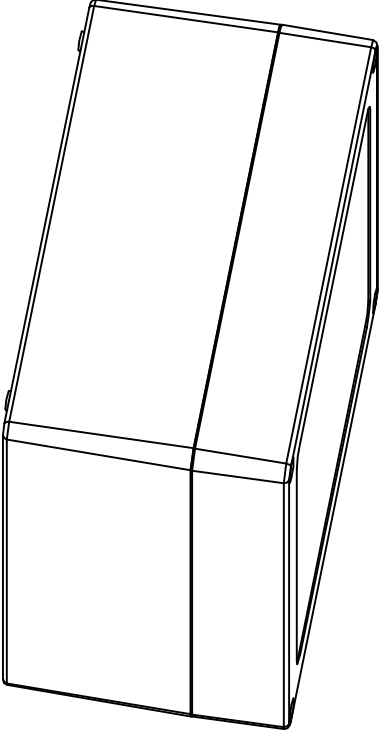

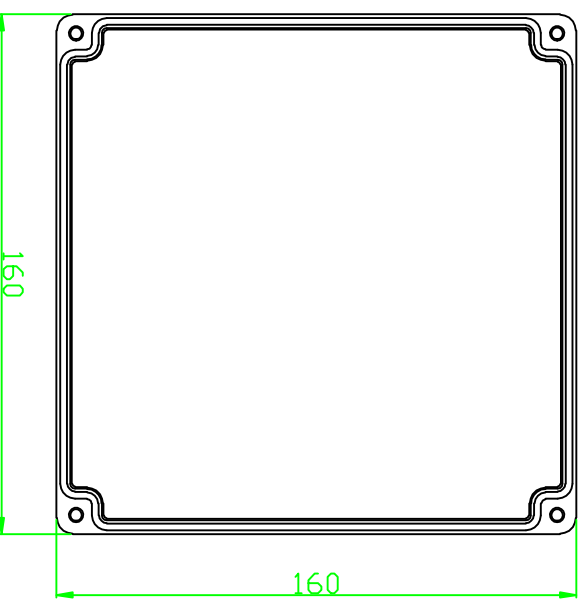

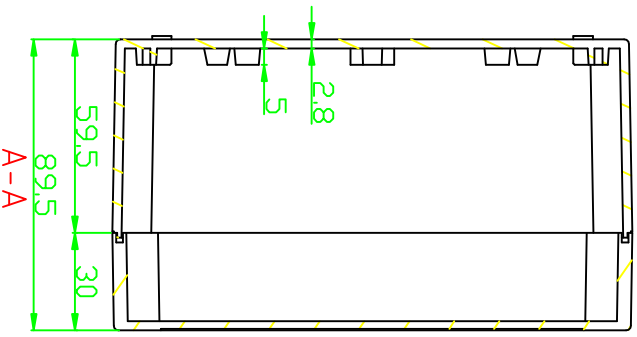

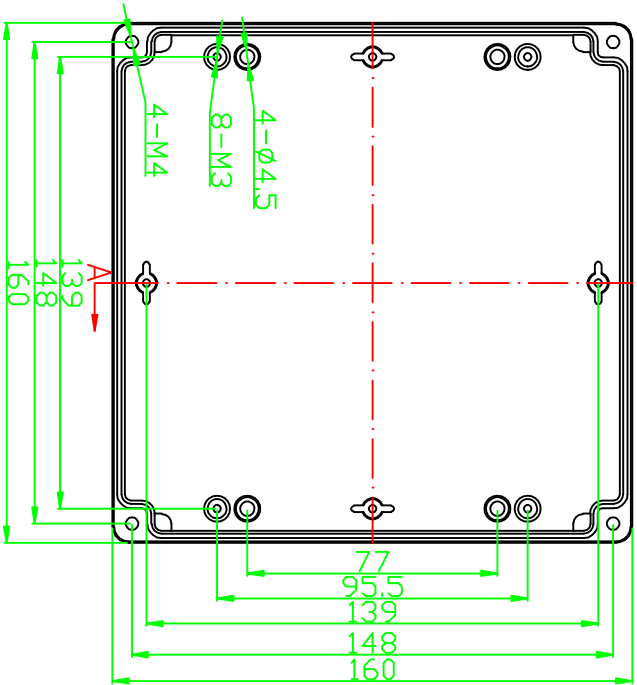



REVISION RECORD				
REV	ECD	DESCRIPTION	DRFT	CHKD



DETACHED LISTS		NAME		DATE	
 (DIM)	TOLERANCES EXCEPT AS NOTED	DRAWN	Kent	10/26/2015	
	ANGLES $\pm 5^\circ$	CHECKED			
	FINISH	ENG APPR			
	MATERIAL: ABS	QTY			
	SCALE: 1:1	 EVEREST WWW.EVERESTCASE.COM			
	TITLE	PW003S			
	DRAWING NO: PW003S	SHEET 1 OF 1			
	/PART NO: 00	SIZE: A4			
	DDI NDT SCALE DRAWING	REV:			